

Pella® Reserve™

Contemporary Clad/Wood



Simple and sophisticated designs that embody the tenets of pure, contemporary style.

Interior



Exterior



- Clean lines**
 Bring your vision to life with expansive glass options combined with some of the narrowest sightlines in the industry.
- Modern hardware**
 Our renowned, exclusive hardware has set the bar for the industry. Featuring sleek lines, the Saldo foldaway crank adds the perfect finishing touch.
- Architectural interest**
 Our industry-leading modern designs with through-stile construction deliver a clean sash joint with pure, 90-degree exteriors. Square grille profiles provide another layer of design flexibility.
- Virtually unlimited customization**
 If you can dream it, we can build it with our most customizable product line. From extra tall to extra wide, Pella can craft unique windows that complement your aesthetic. Custom sizes, grille patterns and designs, finishes, wood types and glass options are available.
- Tailor-made solutions**
 From preliminary drawings to installation, Pella's expert team of architects, engineers, drafters and consultants can work to deliver custom window and door solutions for your project. Partner with Pella to achieve your unique vision without concessions.
- Cutting-edge innovation**
 Our intentional innovations solve modern-day inconveniences without compromising on design. Preserve the beauty of Pella Reserve windows and doors while protecting what matters most with integrated security sensors.
- Durable interiors and extruded aluminum exteriors**
 To help save you time on the jobsite, interior finish options are available in four paints, eleven stains and primed and ready-to-paint. To complement your exterior aesthetic, choose from our carefully curated color palette or define your own custom color for your project.
- ENERGY STAR® certified¹**
 Pella wood products offer energy-efficient options that will meet or exceed ENERGY STAR guidelines in all 50 states. Pella Reserve products with triple-pane glass have been awarded the ENERGY STAR Most Efficient Mark in 2021.¹
- Testing beyond requirements**
 At Pella, our products are tested beyond requirements to help ensure they have long-lasting performance and reduce call-backs for you.
- Best limited lifetime warranty²**
 Pella Reserve products are covered by the best limited lifetime warranty in the business for wood windows and patio doors.²

Available in these window and patio door styles:



Special shape windows also available.

^{1,2} See back cover for disclosures.

Product Specifications

Window & Patio Door Styles	Min. Width	Min. Height	Max. Width	Max. Height	Performance Class & Grade	Performance Values			Frame / Install
						U-Factor	SHGC	STC	
Awning	13-3/4"	13-3/4"	73"	73"	LC30-CW50	0.19-0.48	0.15-0.55	26-34	Fold-out Fin, Block Frame, EnduraClad Exterior Trim/Brickmould
Casement	13-3/4"	13-3/4"	47"	108"	R30-CW50	0.19-0.48	0.15-0.54	26-34	
Fixed Casement	10"	10"	144"	144"	CW30-CW50	0.16-0.50	0.16-0.50	28-33	
In-Swing Hinged Patio Door (Single)	24"	48"	48"	119-1/2"	LC40-LC55	0.25-0.29	0.14-0.40	31-35	
In-Swing Hinged Patio Door (Double)	48"	79-1/2"	96"	119-1/2"	LC40-LC55	0.25-0.29	0.14-0.40	31-35	
Out-Swing Hinged Patio Door (Single)	24"	48"	48"	119-1/2"	LC40-LC70	0.25-0.30	0.14-0.39	30-36	
Out-Swing Hinged Patio Door (Double)	48"	48"	96"	119-1/2"	LC40-LC70	0.25-0.30	0.14-0.39	30-36	
Sliding Patio Door (O)	30-3/4"	74"	60-3/4"	119-1/2"	LC30-LC70	0.25-0.31	0.18-0.51	-	
Sliding Patio Door (OX, XO)	59-1/4"	74"	119-1/2"	119-1/2"	LC30-LC65	0.25-0.31	0.18-0.51	29-35	
Sliding Patio Door (OXO)	90"	74"	180"	119-1/2"	LC30-LC45	0.25-0.31	0.18-0.51	-	
Sliding Patio Door (OXXO)	116-1/8"	74"	236-1/8"	119-1/2"	LC25-LC40	0.25-0.31	0.18-0.51	-	
Multi-Slide Patio Door	41-7/8"	50-1/2"	713-5/8"	119-1/2"	R15-LC25 ³	0.30-0.36	0.15-0.46	31	For more info visit PellaADM.com
Bifold Patio Door	31-3/4"	51-1/2"	312"	119-1/2"	R15-LC25 ³	0.26-0.44	0.13-0.45	-	

Window sizes available in 1/8" increments

Special sizes available. For more information regarding performance, visit pella.com/performance. For more information regarding frame and installation types, visit PellaADM.com.

Grilles

Integral Light Technology*

Choose the look of true divided light featuring the industry's only foam spacer.

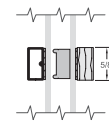

Square⁴ 5/8"

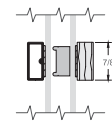

Square⁴ 7/8"

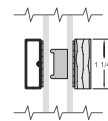

Square⁴ 1 1/4"

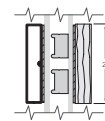

Square⁴ 2"

Attention to Detail

Cross Sections

The venting casement cross sections provide visual reference to the squared-off profile on both the lock and hinge jamb and the consistent sightline this will provide from interior through to exterior.

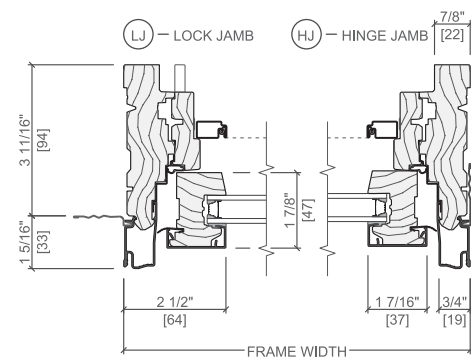

Optional Fold-Out Installation Fin

^{3,4} See back cover for disclosures.

Window Hardware

Modern Collection

Achieve the ultimate contemporary look with exclusive hardware designed by Pella. Our renowned modern hardware has set the bar for the industry. Featuring sleek lines, the Saldo foldaway crank adds the perfect finishing touch.



Fold-away Crank
Saldo

Finishes:

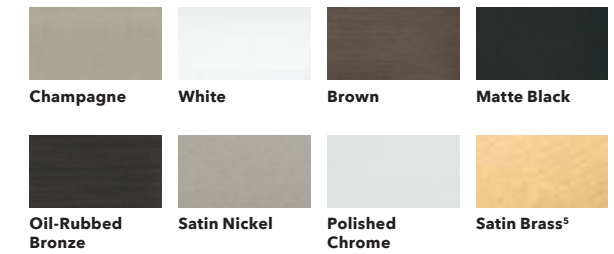

Patio Door Hardware

Modern Collection

Select modern hardware created in collaboration with Baldwin® to achieve the ultimate contemporary look with sleek finishes.

BALDWIN



Hinged & Bifold
Patio Door Handle
Spiere



Sliding & Multi-Slide
Patio Door Handle
Plazo



Multi-Slide Patio
Door Handle^{6,7}

Finishes:

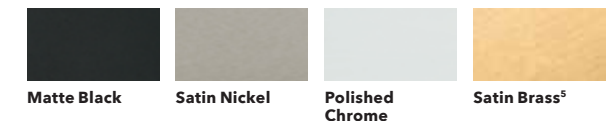

Essential Collection

Elevate your style and transform a home with elegant selections.



Hinged & Bifold
Patio Door Handle



Sliding Patio
Door Handle



Multi-Slide Patio
Door Handle^{6,7}

Finishes:

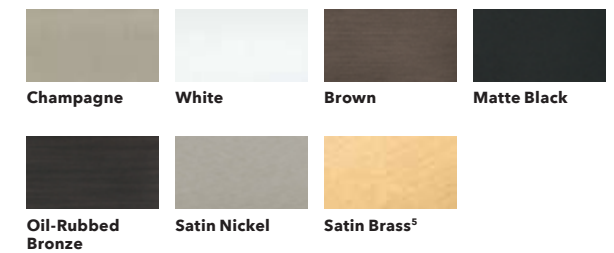

Additional hardware collections available. Visit PellaADM.com for more information.

Added Peace of Mind

Integrated Security Sensors

Integrated wireless security sensors maintain aesthetics, streamline security installation and ensure no warranty loss is caused by post-installation drilling. Sensors can be monitored via the free Pella® Insynctive® App and are compatible with major security panel systems.⁸ For more information, go to connectpella.com.

^{5,6,7,8} See back cover for disclosures.

Colors

Wood Types

Choose the wood species that best complements your project's interior.



Prefinished Pine Interior Colors

Custom interior finishes, unfinished or primed and ready-to-paint are also available.

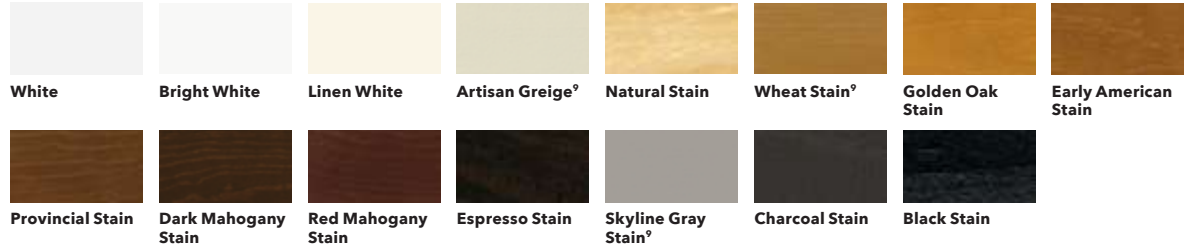

Extruded Aluminum-Clad Exterior Colors

Our low-maintenance EnduraClad® exterior finish resists fading. Take durability one step further with EnduraClad Plus which also resists chalking and corrosion.¹⁰



Custom colors are also available.



The Best Limited Lifetime Warranty in the Industry

We know your reputation matters and you stake your reputation on quality, dependable products. That's why we have the best limited lifetime warranty in the industry for wood windows and patio doors.²

¹ Some Pella products may not meet ENERGY STAR® guidelines in Canada. For more information, contact your local Pella sales representative or go to energystar.gc.ca.
² Based on comparing written limited warranties of leading national wood window and wood patio door brands. See written limited warranty for details, including exceptions and limitations, at pella.com/warranty or contact Pella Customer Service.
³ Ratings are contingent on product configurations.
⁴ Color-matched to your product's interior and exterior color.
⁵ Available Fall 2021.
⁶ Flush multi-slide handle is a Pella exclusive design.
⁷ Flush multi-slide handle is not available in Champagne.
⁸ Requires the Insynctive App on a smart device, an Insynctive Bridge and a wireless home router with internet connection.
⁹ Availability may be limited. Please contact your local Pella rep for details.
¹⁰ EnduraClad Plus protective finish is not available with all colors. See your local Pella sales representative for availability.